

# VERTICAL AHU ENGINEERING SPECIFICATIONS

BULLETIN 20-019 (UK)

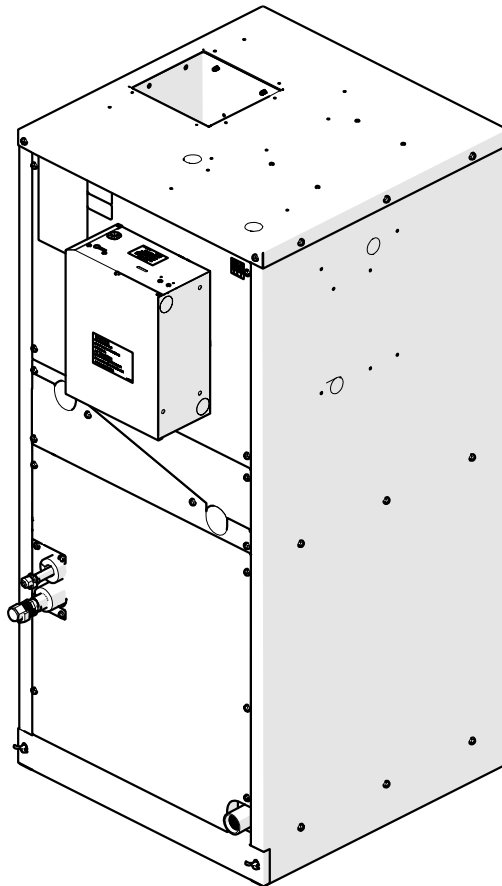

## TABLE OF CONTENTS

APPLICATIONS.....	3
CABINET CONSTRUCTION .....	3
FEATURES AND CONTROLS .....	3
DIMENSIONAL DATA .....	5
SPECIFICATIONS.....	6
HOT WATER COIL PERFORMANCE.....	8
CHILLED WATER COIL PERFORMANCE (COOLING MODE) .....	10
CHILLED WATER COIL PERFORMANCE (HEATING MODE) .....	11
BLOWER PERFORMANCE.....	14
ACOUSTICAL DATA .....	17

Certified to UL Standard 1995  
Conforms to CAN/CSA Standard C22.2 NO. 236



Unico products comply with the European regulations that guarantee product safety.

# DESIGN & SPECIFICATIONS

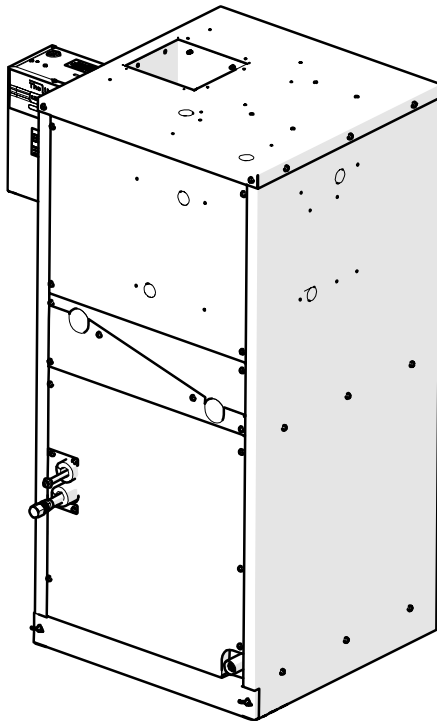

## Model Number Key

V	2430	B-1	EC2	BX	
					<b>Heating Coil</b>
					X=non included
					H=hot water coil included
					<b>Cooling Coil</b>
					B=ac/heat pump coil, 3-row with R410A TXV
					E=ac/heat pump coil, 4-row with R410A TXV
					C=chilled water coil
					<b>Motor Type, Power Supply</b>
					EC2=Variable Speed,
					1 ph, 50/60 Hz, 120/208-230 V
					<b>Revision</b>
					1, 2, 3, etc.
					<b>Configuration</b>
					B=Both left and right hand (universal)
					<b>Nominal Cooling Capacity Range</b>
					2430=24000 to 30000 Btu/hr (7.0 to 8.8 kW)
					3036=30000 to 36000 Btu/hr (8.8 to 10.5 kW)
					3642=36000 to 42000 Btu/hr (10.5 to 12.3 kW)
					<b>Model Series</b>
					V=Single piece vertical fan-coil unit

## APPLICATIONS

The Unico System is a complete indoor comfort system that includes an indoor fan coil unit and small duct system. The fan coil unit and duct system were designed to operate together to provide the proper airflow in every installation. The conditioned air is supplied through a series of small diameter ducts as a stream of air that entrains and mixes with the room air. This process of aspiration produces a more even temperature distribution in the room than a conventional system.

The Unico vertical air handler Unit is a compact one-piece fan coil unit in a vertical up-flow configuration.

For cooling, the unit is designed for R-410A refrigerant (both A/C and Heat Pump) or a chilled water coil. For heating, the unit offers an optional hot water coil or a separately mounted electric heater (Refer to Bulletin 30-34 for proper heater selection).

## CABINET CONSTRUCTION

The cabinet is fully insulated with 1" closed cell foam rubber insulation. The cabinet is constructed of 22 gauge (0.7-mm) galvanized steel with removable access panels on the front for ease of service. See dimensional drawing.

Fan coil ships with a 1 inch (50 mm) MERV 7 pleated filter. It can be upgraded with a higher MERV filter either 1 or 2 inch (50 or 100 mm).

## FEATURES AND CONTROLS

The fan coil unit includes an efficient variable-speed electronically commutated motor (ECM), control box with the S-M-A-R-T<sup>1</sup> control board (SCB) and a USB communications board.

*Balanced wheels* – All blower wheels are individually balanced.

*Direct drive motor* – The wheel is mounted directly to the motor shaft to improve drive efficiency and lower costs.

*Shaft key* – The wheel is attached to the motor shaft using a square keyway instead of a set screw.

*Quick motor replacement (QMR)* – The QMR feature is a quick twist-and-lock motor mount for easy maintenance. The motor is mounted to the inlet ring which is attached to the blower housing with six screws through twist-lock keyholes. When the motor or wheel require service, the entire assembly may be removed as a whole.

*Separate control box* – The control box is separate from the cabinet (ships inside the cabinet) for easy accessibility. It may be mounted to the top or front of the cabinet or even on a wall, whichever is more convenient. Knockout and starter holes for the screws are provided to assist in mounting.

*Control voltage transformer* – a 48VA 24-volt transformer provides control voltage power to the thermostat, electric heaters, and other optional equipment.

<sup>1</sup> Software Managed Airflow Rate and Temperatures

*Heat pump AFS bypass* – removes the anti-frost switch (AFS) from the circuit during heat pump heating mode which eliminates nuisance shutdowns during defrost mode.

*Modes of operation* – The SCB control board has 6 independent modes of operation, each with its own programmable airflow and RPM limit settings (Fan-Only, Low-Cool, High-Cool, Low-Heat, High-Heat, and Emergency-Heat).

*Soft-start and soft-stop* – For quieter operation, the unit will slowly ramp the motor from stop to full speed, and vice versa.

*Constant airflow* – The EC control will deliver the airflow requested without any user adjustments to the duct system or requiring the user to measure the amperage.

*Optimized for efficiency and sound* – The EC control will use the lowest motor speed to achieve the required airflow, which minimizes sound and maximizes electrical efficiency.

*Pre-set airflow rate* – The SCB is pre-programmed with two different air flow rates for the High-Cool Mode. These rates are based on the nominal tonnage of the unit (See the *Applications* section) and can be selected with a board mounted switch. The airflow for each of the six different airflow control modes are a fixed percentage of the selected High Cool airflow.

*Laptop configurable* – The airflow for each Mode of operation is adjustable to any value between the blower minimum and maximum using the ECMconfig software (available for download at [www.unicosystem.com](http://www.unicosystem.com)) and an ordinary USB cable.

*Point-to-point wiring* – The control boards have separate terminals for the thermostat, electric heater, outdoor condenser and other options for easy wiring and troubleshooting.

*Screw terminal connections* – terminal blocks with large screws and wire washers to securely connect the control wires.

*Electric heater interlocks* – The ECM control board includes three electric heater safety lockouts. The lockout prevents the heaters from operating when there is no signal for fan or if the airflow is too low. This prevents the heating elements from overheating, which can severely reduce their useful life.

The other lockout prevents the electric heater third stage from operating if the heat pump is on. This prevents nuisance shutdowns from overheating the electric heater. This feature can be added to the ST control box by using an outside thermostat.

*Boiler relay* – The SCB includes a separate dry-contact relay (HotW) that can be used to turn on the boiler, boiler pump, or hot water coil valve when the system is running in heating mode

*Chilled water relay* – The control box includes a separate dry-contact relay (ColdW) to turn on a chiller or zone pump when the system is running in Cooling mode.

*Fan cycling* – The control board includes a separate switch to provide periodic cycling of the fan. This will minimize or prevent condensation in the ducts located in unconditioned spaces during winter, or to provide fresh air if the system is connected to a fresh air source.

*EAC, ERV, or HRV relay* – For the optimum in indoor air quality, the control board includes a dry-contact relay to turn on an electronic air cleaner, energy recovery ventilator, or heat recovery ventilator any time the fan is on, or to control a fresh air damper for ventilation per ASHRAE 62.2-2010.

*Potable water circulation* – For improved health and safety, the control board provides a switch-selectable feature to turn on the boiler pump periodically (if installed as part of a domestic hot water system) to prevent the formation of stagnant water.

*Humidifier integration* – The control board includes a humidistat input with a humidifier output. If the humidistat calls for humidity, the humidifier output will turn on. It will also turn on the blower at High or Low Heat airflow (User-selectable) if the fan is not already running.

*Air-to-water heat pump (heat pump chiller) compatibility* – For systems with multiple air handlers connected to one AHP. This feature allows one air handler (Leader) to control the mode of operation (heating or cooling) of other connected indoor units (Followers) to avoid runaway cooling or heating.

*Low airflow indicator* – The S.M.A.R.T. control board (SCB) includes an indicator light that signals the user if the desired airflow is not being met. This is usually caused by a restrictive duct system or too few outlets.

*Optimized for zoning* – The ECMconfig software includes programmable motor speed limits to prevent the motor from over-speeding as zone dampers are closed without the need for a bypass damper. Refer to the Unico Tech Bulletin on zoning for more information.

*Laptop troubleshooting* – The ECMconfig software will also provide the user with feedback indicating the actual airflow, motor speed, communication status between the boards and the motor, and the state of various inputs and outputs.

**DIMENSIONAL DATA**

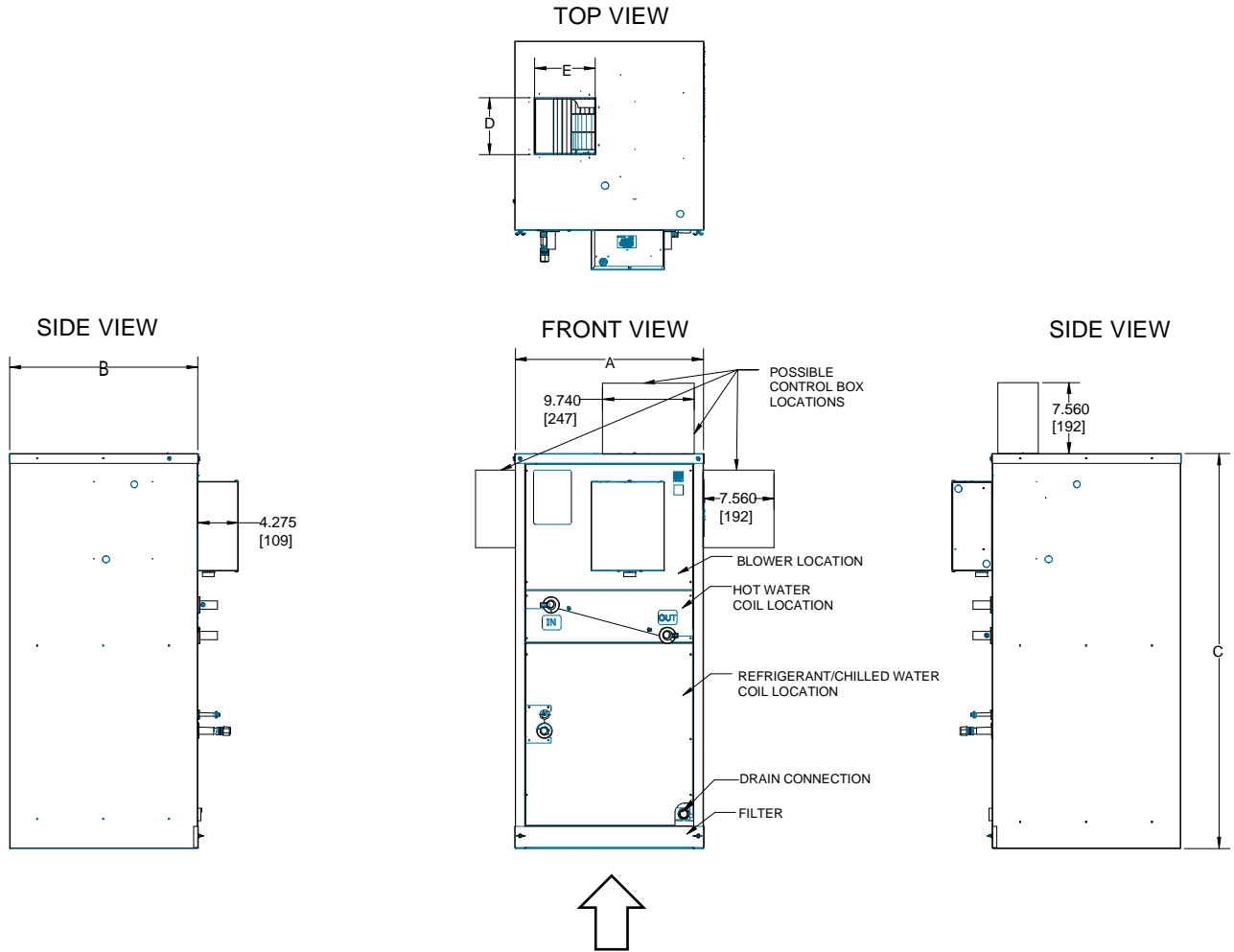

Note: The control box, expansion valve and condensate trap ships inside the spare parts box.

Model	A	B	C	D	E
V2430	20.0 (508)	20.0 (508)	42.0 (1067)	6.0 (152)	6.4 (162)
V3036	20.0 (508)	24.0 (610)	42.0 (1067)	7.1 (179)	6.3 (160)
V3642	23.75 (603)	25.0 (635)	44.0 (1118)	7.16 (182)	6.4 (162)

Model	Filter Size, inch (mm)
V2430	18 x 18 x 1 (457 x 457 x 50)
V3036	18 x 22 x 1 (457 x 559 x 50)
V3642	21 x 22 x 1 (533 x 559 x 50)

**Weights & Shipping Measurements**

Model No.		V2430B-1EC2BX	V2430B-1EC2EX	V3036B-1EC2BX	V3036B-1EC2EX	V3642B-1EC2BX	V3642B-1EC2EX
Weight., lbs. (kg)	Net	117 (53)	109 (50)	138 (63)	129 (59)	151 (68)	163 (74)
	Ship	177 (80)	169 (77)	200 (91)	191 (87)	215 (98)	227 (103)
Shipping Dimensions Inch (mm)	W	27.2 (692)	27.2 (692)	27.2 (692)	27.2 (692)	31.2 (793)	31.2 (793)
	D	21.6 (549)	21.6 (549)	24.6 (625)	24.6 (625)	25.6 (651)	25.6 (651)
	H	44.3 (1125)	44.3 (1125)	44.3 (1125)	44.3 (1125)	46.3 (1176)	46.3 (1176)

**SPECIFICATIONS**

**Blower and Motor Specifications**

Model No.		V2430B-1EC2	V3036B-1EC2	V3642B-1EC2
Electrical Power	Phase, Hz, Volts	1, 50/60, 120/208-230		
Nominal Motor Size	hp (kW)	1/2 (0.37)	1 (0.75)	
Motor Type		EC (variable speed)		
Minimum Circuit Ampacity	amps	7.0/4.0	12.8/7.7	
Max. Over Current Protection	amps	15	20/15	
Motor Full Load Current	amps	5.6/3.2	10.5/6.1	
Motor Speed	RPM	0 – 1800		
Blower Wheel Nom. Diameter	in. (mm)	9.5 (241)		
Blower Wheel Width	in. (mm)	3.75 (95)	5.0 (127)	5.0 (127)
Nominal Air Flow Rate	CFM (L/s)	600 (283)	750 (354)	900 (425)
Nominal Plenum Static Pressure	in. w.c. (kPa)	1.5 (0.373)		
Minimum Plenum Size, ID	in. (mm)	7 (178)	9 (229)	
Sound Pressure Level*	dB(A)	53	53	57
	NC	48	48	52

\* Sound Pressure Level measured for V2430, V3036, and V3642 at 740 CFM, 900 CFM, and 1200 CFM respectively.

**Refrigerant Coil Specifications**

System Type*	AC and Heat Pump			AC and Heat Pump		
Model No.	V2430B-1EC2B	V3036B-1EC2B	V3642B-1EC2B	V2430B-1EC2E	V3036B-1EC2E	V3642B-1EC2E
Coil Part No.	A01948-G01	A01951-G01	A01958-G01	A10914-G01	A01950-G01	A01957-G01
Compatible Condenser Size, ton (kW)	2.0-2.5 (7.0-8.8)	2.5-3.0 (8.8-10.5)	3.0-3.5 (10.5-12.3)	2.0-2.5 (7.0-8.8)	2.5-3.0 (8.8-10.5)	3.0-3.5 (10.5-12.3)
Net Face Area, ft <sup>2</sup> (m <sup>2</sup> )	2.72 (0.25)	3.55 (0.33)	4.75 (0.44)	3.11 (0.29)	4.00 (0.37)	4.75 (0.44)
Tube diameter, in. (mm)	3/8 (9.52)	3/8 (9.52)	3/8 (9.52)	3/8 (9.52)	3/8 (9.52)	3/8 (9.52)
Fin Density, fins/in. (fins/m)	15 (590)	15 (590)	15 (590)	14 (551)	14 (551)	14 (551)
Number of rows	3	3	3	4	4	4
Number of circuits	4	6	6	6	6	8
Design Pressure, psig (MPa)	500 (3.5)	500 (3.5)	500 (3.5)	500 (3.5)	500 (3.5)	500 (3.5)
Refrigerant Type**	R-22, R-407C, R-410A					
Expansion Device	TXV with internal Check Valve (shipped loose)					
TX Valve Part No.	R-22/ R-407C	A00808-002	A00808-004	A00808-004	A00808-002	A00808-004
	R-410A	A00808-013	A00808-014	A00808-014	A00808-013	A00808-014
Suction line†	O.D., inch (mm)	5/8 (15.88)	3/4 (19.05)	3/4 (19.05)	5/8 (15.88)	3/4 (19.05)
	Connection, in.	1/2 Male Flare	5/8 Male Flare	3/4 Male Flare	1/2 Male Flare	5/8 Male Flare
Liquid Line	Part No.	A01910-001	A01952-001	A01959-001	A01910-001	A01952-001
	O.D. inch (mm)	3/8 (9.52)	3/8 (9.52)	3/8 (9.52)	3/8 (9.52)	3/8 (9.52)
	Connection, in.	1/4 Male Flare	3/8 Male Flare	3/8 Male Flare	1/4 Male Flare	3/8 Male Flare
Condensate	Connection, in.	3/4 FPT	3/4 FPT	3/4 FPT	3/4 FPT	3/4 FPT

\* Heat pump coil selection depends on outdoor unit model. Refer to AHRI directory for a proper match.

\*\* Unit ships with R410-A expansion valve. For R-22 and R-407C, order valve separately.

† Suction line stubs with flare nuts are long enough to be cut off and brazed to directly.

**Chilled Water Coil Specifications**

<b>Model No.</b>		V2430-1EC2C	V3036-1EC2C	V3642-1EC2C
CWC model		A02389-G01	A02395-G01	A02396-G01
No. of Rows		4		
Tube diameter	inch (mm)	3/8 (9.5)		
Tube material		Copper		
Fin density	fins/inch (fins/mm)	14 (0.55)		
Fin material		Al		
Design Pressure	Psig (kPa)	320 (2206)	320 (2206)	320 (2206)
Net Face Area, ft <sup>2</sup> (m <sup>2</sup> )		3.11 (0.29)	4.00 (0.37)	4.75 (0.44)
No. of Circuits		6	8	10
Water Connection Size, ODF Sweat	inch [mm]	7/8 (22.2)	7/8 (22.2)	7/8 (22.2)

**Hot Water Coil Specifications**

<b>Model No.</b>		V2430-1EC2*H	V3036-1EC2*H	V364-1EC2*H	
HWC model		HW-V2430	HW-V3036	HW-V3642	
No. of Rows		4			
Tube diameter	inch (mm)	1/2 (12.7)			
Tube material		Cu			
Fin density	fins/in (fins/mm)	10 (0.40)			
Fin material		Al			
Face Area	inch <sup>2</sup> (m <sup>2</sup> )	199 (0.128)	259 (0.167)	342 (0.221)	
No. of Circuits		3			
Connections, ODF	inch (mm)	7/8 (22.2)			
Weight	Net	Lbs. (kg)	8 (3.6)	11 (5.0)	16 (7.3)
	Ship	Lbs. (kg)	12 (5.4)	15 (6.8)	24 (10.9)
Coil Dimensions	W	inch (mm)	17.38 (442)	21.38 (543)	22.38 (569)
	D	inch (mm)	4.50 (114)	4.50 (114)	4.50 (114)
	H	inch (mm)	15.86 (403)	15.86 (403)	19.61 (498)

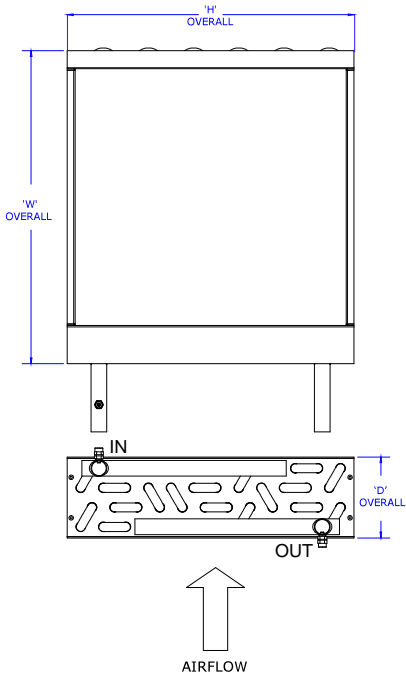

**HOT WATER COIL PERFORMANCE**

<b>V2430</b>		<b>Airflow, SCFM (m<sup>3</sup>/h)</b>						<b>Water Pressure Drop</b>	
<b>Entering Water Temp</b>	<b>Water Flow Rate</b>	400 (680)		500 (850)		600 (1020)			
				<b>Total Capacity</b>					
°F (°C)	GPM (L/s)	MBH (kW)	MBH (kW)	MBH (kW)	MBH (kW)	ft. w.c.	(kPa)		
100 (38)	2 (0.13)	8.50 (2.48)	9.70 (2.84)	10.7 (3.13)	0.47 (1.40)				
	4 (0.25)	9.40 (2.74)	10.9 (3.21)	12.4 (3.62)	1.60 (4.78)				
	6 (0.38)	9.70 (2.83)	11.4 (3.34)	13.0 (3.81)	3.29 (9.83)				
120 (49)	2 (0.13)	14.3 (4.18)	16.3 (4.78)	18.0 (5.28)	0.47 (1.40)				
	4 (0.25)	15.7 (4.59)	18.4 (5.38)	20.7 (6.08)	1.60 (4.78)				
	6 (0.38)	16.2 (4.74)	19.1 (5.60)	21.8 (6.38)	3.29 (9.83)				
140 (60)	2 (0.13)	20.1 (5.89)	23.0 (6.74)	25.4 (7.46)	0.47 (1.40)				
	4 (0.25)	22.0 (6.46)	25.8 (7.57)	29.2 (8.56)	1.60 (4.78)				
	6 (0.38)	22.7 (6.65)	26.9 (7.87)	30.6 (8.97)	3.29 (9.83)				
160 (71)	2 (0.13)	26.0 (7.62)	29.8 (8.73)	33.0 (9.66)	0.47 (1.40)				
	4 (0.25)	28.4 (8.33)	33.4 (9.78)	37.8 (11.1)	1.60 (4.78)				
	6 (0.38)	29.3 (8.58)	34.7 (10.2)	39.5 (11.6)	3.29 (9.83)				
<b>Recommended No. of Outlets</b>		12		15		18			

<b>V3036</b>		<b>Airflow, SCFM (m<sup>3</sup>/h)</b>						<b>Water Pressure Drop</b>	
<b>Entering Water Temp</b>	<b>Water Flow Rate</b>	450 (760)		625 (1060)		750 (1270)			
				<b>Total Capacity</b>					
°F (°C)	GPM (L/s)	MBH (kW)	MBH (kW)	MBH (kW)	MBH (kW)	ft. w.c.	(kPa)		
100 (38)	2 (0.13)	9.80 (2.86)	11.8 (3.46)	12.9 (3.77)	13.9 (3.79)	0.56 (1.7)			
	4 (0.25)	10.8 (4.07)	13.6 (3.16)	15.3 (3.98)	16.8 (4.45)	1.90 (5.7)			
	6 (0.38)	11.1 (4.48)	14.3 (4.92)	16.2 (3.26)	17.9 (4.18)	3.89 (11.6)			
	8 (0.50)	11.3 (4.70)	14.6 (4.75)	16.7 (5.26)	18.6 (3.32)	6.48 (19.4)			
120 (49)	2 (0.13)	16.4 (4.80)	19.9 (5.82)	21.8 (6.35)	23.4 (6.39)	0.56 (1.7)			
	4 (0.25)	18.1 (6.86)	22.8 (5.29)	25.7 (6.68)	28.2 (7.46)	1.90 (5.7)			
	6 (0.38)	18.6 (7.52)	23.9 (8.27)	27.1 (5.46)	30.1 (6.99)	3.89 (11.6)			
	8 (0.50)	18.9 (7.88)	24.4 (7.95)	27.9 (8.82)	31.1 (5.54)	6.48 (19.4)			
140 (60)	2 (0.13)	23.1 (6.76)	28.0 (8.21)	30.8 (8.98)	33.1 (9.02)	0.56 (1.7)			
	4 (0.25)	25.4 (9.69)	32.1 (7.43)	36.2 (9.40)	39.8 (10.5)	1.90 (5.7)			
	6 (0.38)	26.1 (10.6)	33.5 (11.6)	38.2 (7.66)	42.3 (9.83)	3.89 (11.6)			
	8 (0.50)	26.5 (11.1)	34.3 (11.2)	39.2 (12.4)	43.7 (7.77)	6.48 (19.4)			
160 (71)	2 (0.13)	29.8 (8.74)	36.3 (10.6)	39.8 (11.6)	42.8 (11.7)	0.56 (1.7)			
	4 (0.25)	32.7 (12.6)	41.4 (9.59)	46.7 (12.1)	51.4 (13.6)	1.90 (5.7)			
	6 (0.38)	33.7 (13.7)	43.3 (15.1)	49.2 (9.87)	54.6 (12.7)	3.89 (11.6)			
	8 (0.50)	34.2 (14.3)	44.2 (14.4)	50.5 (16.0)	56.3 (10.0)	6.48 (19.4)			
<b>Recommended No. of Outlets</b>		14		19		23		27	

**WARNING!**  
 To prevent injury or damage from high temperatures, do not install floor outlets when operating with discharge temperature above 160°F (71°C).

**Caution**  
 To prevent damage to the EC motor from overheating, do not operate in the shaded region where discharge temperature is more 150 °F (65 °C).



<b>V3642</b>		<b>Airflow, SCFM (m<sup>3</sup>/h)</b>								<b>Water Pressure Drop</b>			
<b>Entering Water Temp</b>	<b>Water Flow Rate</b>	500	(850)	750	(1270)	875	(1490)	1000	(1700)				
		<b>Total Capacity</b>											
°F	(°C)	GPM	(L/s)	MBH	(kW)	MBH	(kW)	MBH	(kW)	MBH	(kW)	ft. w.c.	(kPa)
100	(38)	2	(0.13)	11.1	3.26	14.0	4.10	15.1	4.42	16.0	4.68	0.72	(2.2)
		4	(0.25)	12.3	3.61	16.4	4.81	18.1	5.31	19.7	5.76	2.47	(7.4)
		6	(0.38)	12.7	3.72	17.3	5.07	19.3	5.65	21.1	6.18	5.08	(15.2)
		8	(0.50)	12.9	3.78	17.7	5.20	19.9	5.82	21.8	6.40	8.45	(25.3)
		10	(0.63)	13.0	3.82	18.0	5.28	20.2	5.93	22.3	6.53	12.55	(37.5)
120	(49)	2	(0.13)	18.7	5.47	23.5	6.89	25.3	7.43	26.9	7.88	0.72	(2.2)
		4	(0.25)	20.6	6.04	27.5	8.06	30.4	8.91	33.0	9.66	2.47	(7.4)
		6	(0.38)	21.2	6.22	28.9	8.48	32.3	9.46	35.3	10.35	5.08	(15.2)
		8	(0.50)	21.6	6.31	29.7	8.69	33.2	9.74	36.5	10.70	8.45	(25.3)
		10	(0.63)	21.7	6.37	30.1	8.82	33.8	9.91	37.3	10.92	12.55	(37.5)
140	(60)	2	(0.13)	26.2	7.69	33.2	9.71	35.7	10.47	37.9	11.10	0.72	(2.2)
		4	(0.25)	28.9	8.48	38.7	11.34	42.8	12.53	46.4	13.6	2.47	(7.4)
		6	(0.38)	29.8	8.73	40.7	11.91	45.4	13.29	49.6	14.55	5.08	(15.2)
		8	(0.50)	30.2	8.86	41.6	12.20	46.7	13.68	51.3	15.04	8.45	(25.3)
		10	(0.63)	30.5	8.93	42.2	12.38	47.5	13.91	52.3	15.34	12.55	(37.5)
160	(71)	2	(0.13)	33.9	9.93	42.8	12.55	46.2	13.53	49.0	14.36	0.72	(2.2)
		4	(0.25)	37.3	10.92	49.9	14.63	55.2	16.18	59.9	17.56	2.47	(7.4)
		6	(0.38)	38.4	11.25	52.4	15.36	58.5	17.14	64.0	18.77	5.08	(15.2)
		8	(0.50)	38.9	11.40	53.7	15.72	60.2	17.63	66.2	19.39	8.45	(25.3)
		10	(0.63)	39.2	11.50	54.4	15.94	61.2	17.92	67.5	19.77	12.55	(37.5)
<b>Recommended No. of Outlets</b>		15		23		27		30					

Capacities are based on 70°F (21°C) return air temperature ( $T_m$ )

Conversion Factors: MBH = 1000 Btu/hr, 1 kW = 3413 Btu/hr

Recommended number of outlets is based on 33 CFM (60 m<sup>3</sup>/h) per outlet for a quiet system.

**WARNING!**  
To prevent injury or damage from high temperatures, do not install floor outlets when operating with discharge temperature above 160°F (71°C).

**Caution**  
To prevent damage to the EC motor from overheating, do not operate in the shaded region where discharge temperature is more 150 °F (65 °C).

Hot Water Coil Air Pressure Drop, in. w.c., (Pa)

<b>Air Flow Rate</b>		<b>Hot Water Coil Model</b>					
CFM	(m <sup>3</sup> /h)	<b>HW-V2430</b>		<b>HW-V3036</b>		<b>HW-V3642</b>	
400	(680)	0.11	(26)	0.08	(20)	-	
500	(850)	0.16	(39)	0.10	(25)	0.06	(15)
625	(1060)	0.23	(58)	0.15	(36)	0.09	(22)
750	(1270)	0.32	(80)	0.20	(50)	0.12	(31)
875	(1490)	-		0.27	(66)	0.16	(40)
1000	(1700)	-		0.34	(83)	0.21	(51)
1100	(1870)	-		-		0.24	(60)
1250	(2120)	-		-		-	

Note: Evaluated at 70°F db (21°C)

**CHILLED WATER COIL PERFORMANCE (COOLING MODE)**

The performance tables below are based on 80°F db/67°F wb (27°C db/19°C wb) entering air and pure water. See capacity multiplier tables for correction factors for different temperatures and glycol concentrations.

V2430				Airflow												Water Pressure Drop	
Entering Water Temp		Water Flow Rate		300CFM (142 L/s)			400CFM (189 L/s)			500CFM (236L/s)			625CFM (295 L/s)				
				Total Capacity		SHR	Total Capacity		SHR	Total Capacity		SHR	Total Capacity		SHR		
°F	°C	GPM	L/s	MBH	kW		MBH	MBH		kW	MBH		kW	kW		MBH	kW
40	4.4	2	0.13	16.1	4.7	0.62	18.8	5.5	0.63	20.6	6.0	0.66	22	6.6	0.70	1.19	3.56
		4	0.25	18.3	5.4	0.60	22.8	6.7	0.60	26.6	7.8	0.62	30	8.9	0.63	4.06	12.14
		6	0.38	18.8	5.5	0.60	24.2	7.1	0.60	28.8	8.4	0.61	34	9.8	0.62	8.34	24.93
46	7.7	2	0.13	13.1	3.8	0.66	15.2	4.5	0.69	16.8	4.9	0.73	18	5.4	0.77	1.19	3.56
		4	0.25	15.0	4.4	0.63	18.6	5.5	0.64	21.6	6.3	0.66	24	7.2	0.68	4.06	12.14
		6	0.38	15.4	4.5	0.62	19.8	5.8	0.63	23.4	6.9	0.64	27	8.0	0.65	8.34	24.93
50	10.0	2	0.13	11.0	3.2	0.70	12.9	3.8	0.74	14.3	4.2	0.78	16	4.6	0.84	1.19	3.56
		4	0.25	12.6	3.7	0.66	15.7	4.6	0.68	18.1	5.3	0.70	21	6.0	0.72	4.06	12.14
		6	0.38	13.0	3.8	0.65	16.6	4.9	0.66	19.6	5.7	0.68	23	6.7	0.69	8.34	24.93
55	12.8	2	0.13	8.2	2.4	0.80	9.8	2.9	0.86	11.2	3.3	0.90	12	3.6	1.00	1.19	3.56
		4	0.25	9.4	2.8	0.74	11.7	3.4	0.77	13.5	4.0	0.81	16	4.5	0.84	4.06	12.14
		6	0.38	9.7	2.8	0.74	12.4	3.6	0.75	14.7	4.3	0.77	17	5.0	0.80	8.34	24.93
Recommended No. of Outlets				12			15			18			21				

V3036				Airflow												Water Pressure Drop	
Entering Water Temp		Water Flow Rate		500CFM (236 L/s)			600CFM (283L/s)			700CFM (330 L/s)			800CFM (378L/s)				
				Total Capacity		SHR	Total Capacity		SHR	Total Capacity		SHR	Total Capacity		SHR		
°F	°C	GPM	L/s	MBH	kW		MBH	kW		MBH	kW		MBH	kW		MBH	kW
40	4.4	2	0.13	21.2	6.2	0.662	22.6	6.6	0.687	23.8	7.0	0.718	24.8	7.3	0.751	0.62	1.85
		4	0.25	27.2	8.0	0.614	30.4	8.9	0.623	37.0	10.8	0.640	39.5	11.6	0.639	2.11	6.31
		6	0.38	29.4	8.6	0.608	33.6	9.8	0.611	42.0	12.3	0.622	45.5	13.3	0.626	4.32	12.91
		8	0.50	30.4	8.9	0.600	35.2	10.3	0.605	44.5	13.0	0.614	48.5	14.2	0.620	7.19	21.49
45	7.2	2	0.13	17.9	5.2	0.697	19.3	5.7	0.741	23.0	6.7	0.780	24.0	7.0	0.808	0.62	1.85
		4	0.25	23.2	6.8	0.638	25.8	7.6	0.652	31.2	9.1	0.675	33.4	9.8	0.691	2.11	6.31
		6	0.38	25.0	7.3	0.625	28.4	8.3	0.633	35.2	10.3	0.645	38.5	11.3	0.657	4.32	12.91
		8	0.50	25.8	7.6	0.625	29.8	8.7	0.628	37.6	11.0	0.637	41.0	12.0	0.647	7.19	21.49
50	10.0	2	0.13	14.7	4.3	0.771	16.0	4.7	0.810	19.1	5.6	0.853	20.0	5.9	0.903	0.62	1.85
		4	0.25	18.7	5.5	0.686	20.8	6.1	0.717	25.4	7.4	0.742	27.0	7.9	0.764	2.11	6.31
		6	0.38	20.2	5.9	0.671	23.0	6.7	0.685	28.6	8.4	0.699	30.8	9.0	0.714	4.32	12.91
		8	0.50	20.8	6.1	0.665	24.0	7.0	0.668	30.2	8.9	0.683	33.2	9.7	0.695	7.19	21.49
55	12.8	2	0.13	11.5	3.4	0.892	12.7	3.7	0.930	15.1	4.4	1.000	16.2	4.7	1.000	0.62	1.85
		4	0.25	13.9	4.1	0.796	15.6	4.6	0.828	19.2	5.6	0.861	20.8	6.1	0.885	2.11	6.31
		6	0.38	15.0	4.4	0.766	17.2	5.0	0.784	21.2	6.2	0.810	23.2	6.8	0.824	4.32	12.91
		8	0.50	15.5	4.5	0.749	17.9	5.2	0.759	22.6	6.6	0.784	24.6	7.2	0.795	7.19	21.49
Recommended No. of Outlets				15			18			21			24				

V3642				Airflow												Water Pressure Drop	
Entering Water Temp		Water Flow Rate		600CFM (283L/s)			800CFM (378L/s)			1000CFM (472L/s)			1100CFM (519L/s)				
				Total Capacity		SHR	Total Capacity		SHR	Total Capacity		SHR	Total Capacity		SHR		
°F	°C	GPM	L/s	MBH	kW		MBH	kW		MBH	kW		MBH	kW		ft. w.g.	kPa
40	4.4	4	0.13	30.0	8.8	0.625	34.6	10.1	0.653	37.8	11.1	0.684	39.0	11.4	0.701	1.17	3.50
		6	0.25	33.4	9.8	0.611	40.0	11.7	0.626	44.5	13.0	0.644	46.5	13.6	0.655	2.39	7.14
		8	0.38	35.0	10.3	0.608	43.0	12.6	0.617	49.0	14.4	0.630	51.5	15.1	0.633	3.98	11.90
		10	0.50	36.0	10.6	0.613	45.0	13.2	0.612	52.0	15.2	0.619	55.0	16.1	0.624	5.91	17.66
45	7.2	4	0.13	25.4	7.4	0.656	29.2	8.6	0.692	32.0	9.4	0.732	33.2	9.7	0.757	1.17	3.50
		6	0.25	28.2	8.3	0.639	33.6	9.8	0.657	37.8	11.1	0.682	39.5	11.6	0.703	2.39	7.14
		8	0.38	29.8	8.7	0.624	36.2	10.6	0.644	41.5	12.2	0.660	43.5	12.7	0.675	3.98	11.90
		10	0.50	30.4	8.9	0.622	37.8	11.1	0.634	43.5	12.7	0.652	46.0	13.5	0.663	5.91	17.66
50	10.0	4	0.13	20.6	6.0	0.714	23.8	7.0	0.763	26.4	7.7	0.816	27.4	8.0	0.838	1.17	3.50
		6	0.25	22.8	6.7	0.690	27.2	8.0	0.717	30.6	9.0	0.758	32.0	9.4	0.776	2.39	7.14
		8	0.38	24.0	7.0	0.668	29.2	8.6	0.700	33.4	9.8	0.719	35.0	10.3	0.736	3.98	11.90
		10	0.50	24.8	7.3	0.664	30.6	9.0	0.686	35.2	10.3	0.708	37.2	10.9	0.717	5.91	17.66
55	12.8	4	0.13	15.5	4.5	0.823	18.3	5.4	0.895	20.0	5.9	1.000	21.2	6.2	1.000	1.17	3.50
		6	0.25	17.0	5.0	0.790	20.4	6.0	0.832	23.2	6.8	0.874	24.6	7.2	0.900	2.39	7.14
		8	0.38	17.9	5.2	0.759	21.8	6.4	0.799	25.0	7.3	0.836	26.6	7.8	0.853	3.98	11.90
		10	0.50	18.4	5.4	0.750	22.6	6.6	0.779	26.4	7.7	0.817	28.0	8.2	0.833	5.91	17.66
Recommended No. of Outlets				21			24			27			30				

**CHILLED WATER COIL PERFORMANCE (HEATING MODE)**

The performance tables below are based on 70°F db (21°C db) entering air. See capacity multiplier tables for correction factors for different temperatures and glycol concentrations.

V2430				Airflow								Water Pressure Drop	
Entering Water Temp		Water Flow Rate		300CFM (142 L/s)		400CFM (189 L/s)		500CFM (236L/s)		625CFM (295 L/s)			
				Total Capacity		Total Capacity		Total Capacity		Total Capacity			
°F	°C	GPM	L/s	MBH	kW	MBH	kW	MBH	kW	MBH	kW	ft. w.g.	kPa
95	35	2	0.13	7.2	2.1	9.3	2.7	11.1	3.3	12.9	3.8	1.19	3.56
		4	0.25	7.3	2.1	9.7	2.8	11.9	3.5	14.4	4.2	4.06	12.14
		6	0.38	7.4	2.2	9.7	2.8	12.1	3.5	14.8	4.3	8.34	24.93
110	43.3	2	0.13	11.6	3.4	15.0	4.4	17.8	5.2	20.8	6.1	0.86	2.57
		4	0.25	11.7	3.4	15.5	4.5	19.1	5.6	23.2	6.8	2.95	8.82
		6	0.38	11.8	3.5	15.6	4.6	19.3	5.7	23.6	6.9	6.06	18.11
120	48.9	2	0.13	14.5	4.2	18.7	5.5	22.4	6.6	26.0	7.6	0.86	2.57
		4	0.25	14.7	4.3	19.4	5.7	23.8	7.0	29.0	8.5	2.95	8.82
		6	0.38	14.7	4.3	19.5	5.7	24.2	7.1	29.6	8.7	6.06	18.11
140	60.0	2	0.13	20.4	6.0	26.2	7.7	31.4	9.2	36.6	10.7	0.86	2.57
		4	0.25	20.6	6.0	27.2	8.0	33.4	9.8	40.5	11.9	2.95	8.82
		6	0.38	20.6	6.0	27.4	8.0	33.8	9.9	41.5	12.2	6.06	18.11
160	71.1	2	0.13	26.2	7.7	33.8	9.9	40.5	11.9	47.0	13.8	0.86	2.57
		4	0.25	26.4	7.7	35.0	10.3	43.0	12.6	52.5	15.4	2.95	8.82
		6	0.38	26.6	7.8	35.2	10.3	43.5	12.7	53.5	15.7	6.06	18.11
Recommended No. of Outlets				12		15		18		21			

**WARNING!**  
To prevent injury or damage from high temperatures, do not install floor outlets when operating with discharge temperature above 160°F (71°C).

**Caution**  
To prevent damage to the EC motor from overheating, do not operate in the shaded region where discharge temperature is more 150 °F (65 °C).

V3036				Airflow								Water Pressure Drop	
Entering Water Temp		Water Flow Rate		500CFM (236 L/s)		600CFM (283L/s)		700CFM (330 L/s)		800CFM (378L/s)			
				Total Capacity		Total Capacity		Total Capacity		Total Capacity			
°F	°C	GPM	L/s	MBH	kW	MBH	kW	MBH	kW	MBH	kW	ft. w.g.	kPa
95	35	2	0.13	11.3	3.3	12.9	3.8	14.1	4.1	15.1	4.4	0.62	1.85
		4	0.25	12.0	3.5	14.2	4.2	16.1	4.7	17.9	5.2	2.11	6.31
		6	0.38	12.2	3.6	14.4	4.2	16.6	4.9	18.7	5.5	4.32	12.91
		8	0.50	12.2	3.6	14.5	4.2	16.8	4.9	19.0	5.6	7.19	21.49
110	43.3	2	0.13	18.2	5.3	20.6	6.0	22.8	6.7	24.4	7.2	0.45	1.35
		4	0.25	19.3	5.7	22.8	6.7	26.0	7.6	28.8	8.4	1.53	4.57
		6	0.38	19.5	5.7	23.2	6.8	26.6	7.8	30.0	8.8	3.14	9.39
		8	0.50	19.5	5.7	23.2	6.8	26.8	7.9	30.4	8.9	5.22	15.60
120	48.9	2	0.13	22.8	6.7	26.0	7.6	28.6	8.4	30.6	9.0	0.45	1.35
		4	0.25	24.2	7.1	28.4	8.3	32.4	9.5	36.2	10.6	1.53	4.57
		6	0.38	24.4	7.2	29.0	8.5	33.4	9.8	37.4	11.0	3.14	9.39
		8	0.50	24.4	7.2	29.0	8.5	33.6	9.8	38.0	11.1	5.22	15.60
140	60.0	2	0.13	32.0	9.4	36.4	10.7	40.0	11.7	43.0	12.6	0.45	1.35
		4	0.25	33.8	9.9	40.0	11.7	45.5	13.3	50.5	14.8	1.53	4.57
		6	0.38	34.0	10.0	40.5	11.9	46.5	13.6	52.5	15.4	3.14	9.39
		8	0.50	34.2	10.0	41.0	12.0	47.0	13.8	53.5	15.7	5.22	15.60
160	71.1	2	0.13	41.5	12.2	47.0	13.8	52.0	15.2	55.5	16.3	0.45	1.35
		4	0.25	43.5	12.7	51.5	15.1	58.5	17.1	65.5	19.2	1.53	4.57
		6	0.38	44.0	12.9	52.0	15.2	60.0	17.6	67.5	19.8	3.14	9.39
		8	0.50	44.0	12.9	52.5	15.4	60.5	17.7	68.5	20.1	5.22	15.60
<b>Recommended No. of Outlets</b>				15		18		21		24			

**WARNING!**  
 To prevent injury or damage from high temperatures, do not install floor outlets when operating with discharge temperature above 160°F (71°C).

**Caution**  
 To prevent damage to the EC motor from overheating, do not operate in the shaded region where discharge temperature is more 150 °F (65 °C).

V3642				Airflow								Water Pressure Drop	
Entering Water Temp		Water Flow Rate		600CFM (283L/s)		800CFM (378L/s)		1000CFM (472L/s)		1100CFM (519L/s)			
				Total Capacity		Total Capacity		Total Capacity		Total Capacity			
°F	°C	GPM	L/s	MBH	kW	MBH	kW	MBH	kW	MBH	kW	ft. w.g.	kPa
95	35	4	0.13	14.1	4.1	17.9	5.2	21.0	6.2	22.2	6.5	1.17	3.50
		6	0.25	14.4	4.2	18.6	5.5	22.4	6.6	24.0	7.0	2.39	7.14
		8	0.38	14.5	4.2	19.0	5.6	23.0	6.7	24.8	7.3	3.98	11.90
		10	0.50	14.6	4.3	19.1	5.6	23.4	6.9	25.2	7.4	5.91	17.66
110	43.3	4	0.13	22.6	6.6	28.8	8.4	33.8	9.9	35.8	10.5	0.85	2.54
		6	0.25	23.2	6.8	30.0	8.8	36.0	10.6	38.5	11.3	1.74	5.20
		8	0.38	23.2	6.8	30.4	8.9	36.8	10.8	40.0	11.7	2.89	8.64
		10	0.50	23.4	6.9	30.6	9.0	37.4	11.0	40.5	11.9	4.3	12.85
120	48.9	4	0.13	28.4	8.3	36.0	10.6	42.5	12.5	45.0	13.2	0.85	2.54
		6	0.25	29.0	8.5	37.4	11.0	45.0	13.2	48.5	14.2	1.74	5.20
		8	0.38	29.2	8.6	38.0	11.1	46.0	13.5	50.0	14.7	2.89	8.64
		10	0.50	29.2	8.6	38.5	11.3	47.0	13.8	51.0	14.9	4.3	12.85
140	60.0	4	0.13	40.0	11.7	50.5	14.8	59.5	17.4	63.5	18.6	0.85	2.54
		6	0.25	40.5	11.9	52.5	15.4	63.5	18.6	68.0	19.9	1.74	5.20
		8	0.38	41.0	12.0	53.5	15.7	65.0	19.0	70.0	20.5	2.89	8.64
		10	0.50	41.0	12.0	53.5	15.7	65.5	19.2	71.0	20.8	4.3	12.85
160	71.1	4	0.13	51.5	15.1	65.5	19.2	77.0	22.6	82.0	24.0	0.85	2.54
		6	0.25	52.0	15.2	67.5	19.8	81.5	23.9	88.0	25.8	1.74	5.20
		8	0.38	52.5	15.4	68.5	20.1	83.5	24.5	90.5	26.5	2.89	8.64
		10	0.50	52.5	15.4	69.0	20.2	84.5	24.8	92.0	27.0	4.3	12.85
<b>Recommended No. of Outlets</b>				21		24		27		30			

**WARNING!**

To prevent injury or damage from high temperatures, do not install floor outlets when operating with discharge temperature above 160°F (71°C).

**Caution**

To prevent damage to the EC motor from overheating, do not operate in the shaded region where discharge temperature is more 150 °F (65 °C).

**BLOWER PERFORMANCE**

**V2430B-1EC2**

**50/60 Hz**

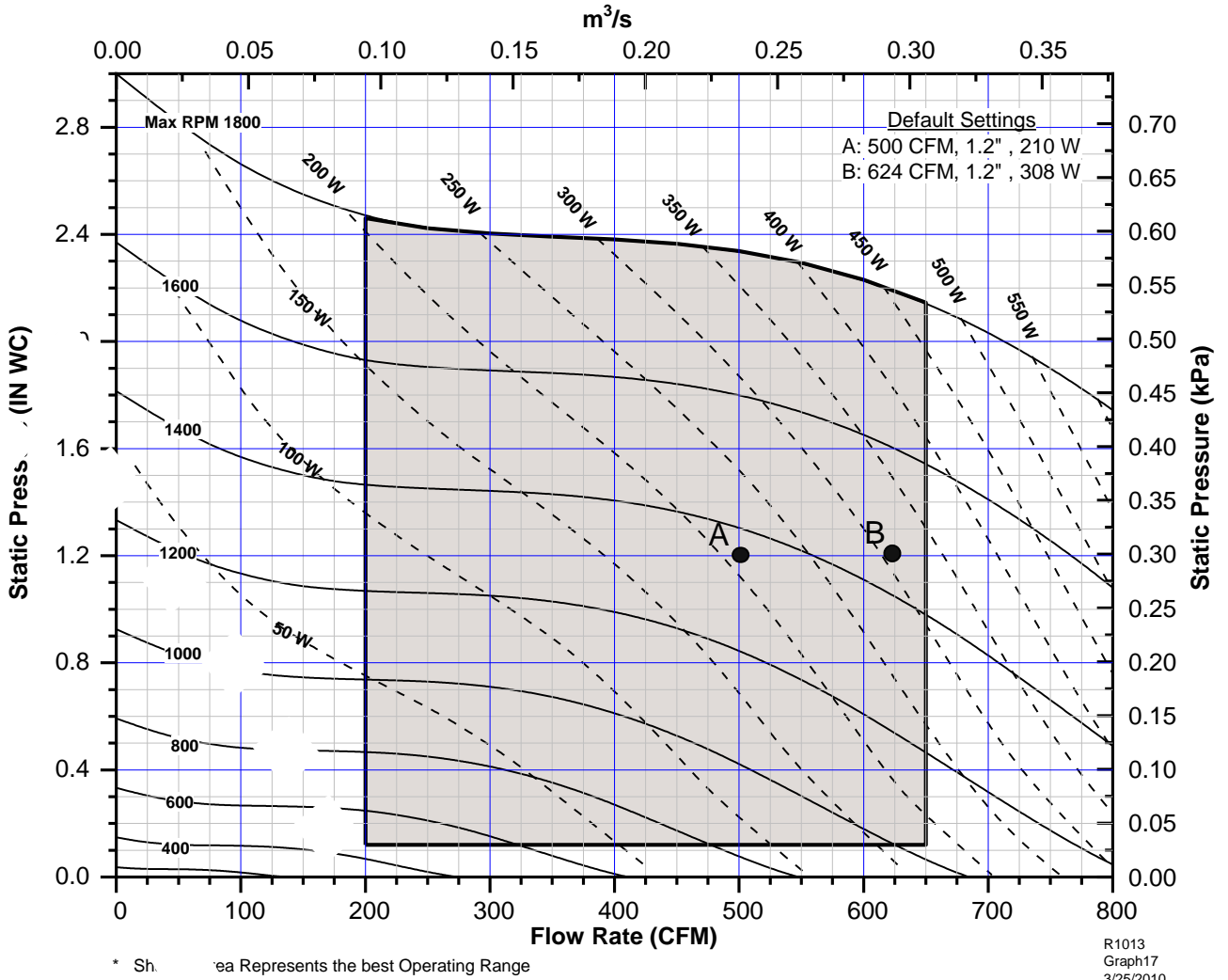

R1013  
Graph17  
3/25/2010

SP, in. wc (Pa)	0.25 (62)	0.5 (124)	0.75 (186)	1 (248)	1.2 (298)	1.5 (373)	1.75 (435)
CFM (m³/hr)	RPM W	RPM W	RPM W	RPM W	RPM W	RPM W	RPM W
100 (0.05)	580 10	810 20	990 30	1140 45	1240 55	1380 75	1480 90
200 (0.09)	600 15	830 30	1010 50	1160 70	1270 85	1420 110	1530 130
300 (0.14)	680 35	860 50	1020 75	1170 95	1280 115	1430 150	1540 175
400 (0.19)	790 60	940 85	1070 110	1200 135	1300 160	1440 195	1550 225
500 (0.24)	910 105	1040 130	1160 160	1270 190	1360 215	1480 255	1580 290
600 (0.28)	1040 165	1150 195	1260 230	1360 265	1430 290	1540 335	1630 375
700 (0.33)	1170 245	1280 285	1370 325	1460 360	1530 395	1630 440	1710 485
800 (0.38)	1310 355	1400 400	1490 445	1570 485	1640 520	1730 575	1800 620

V3036B-1EC2

50/60 Hz

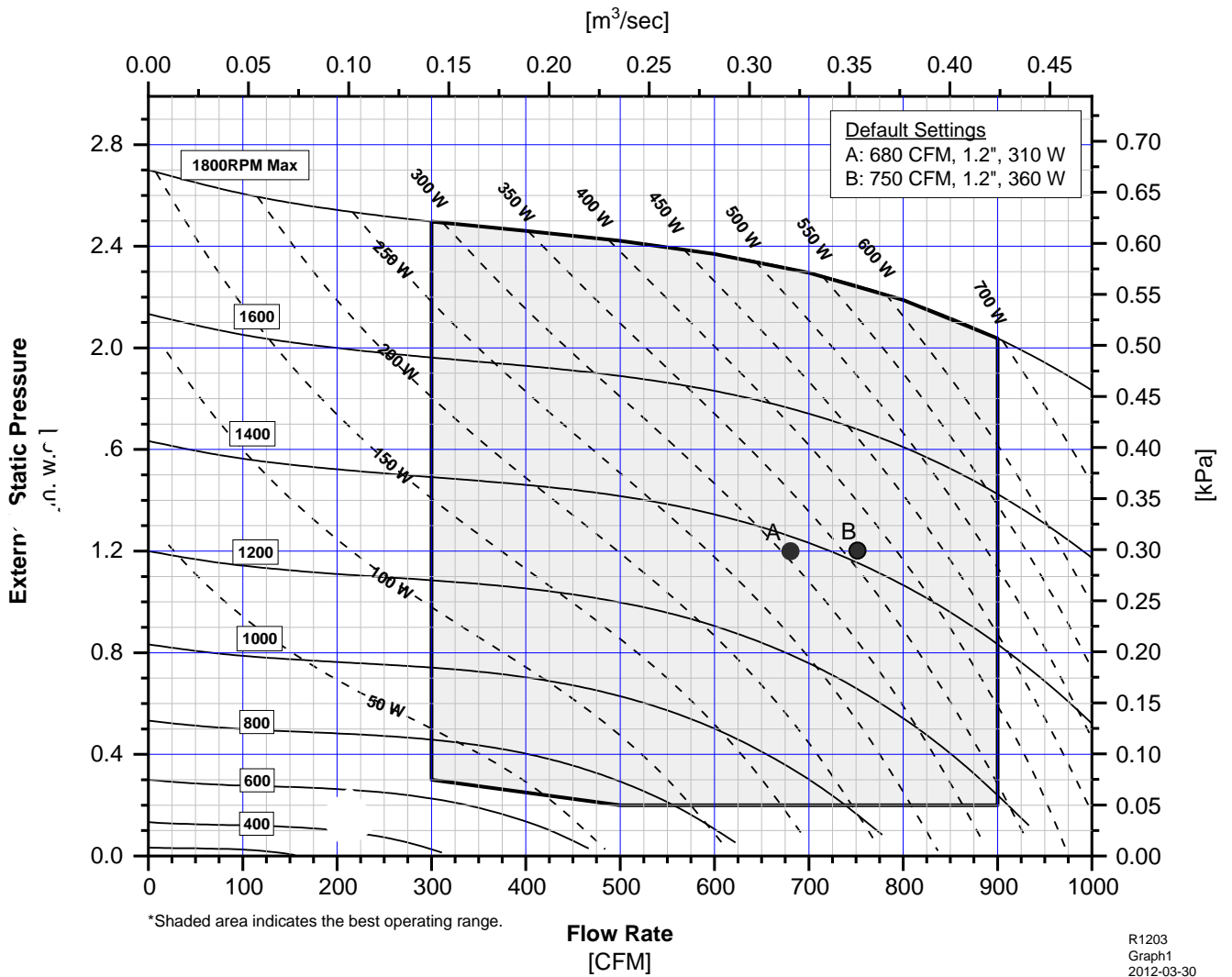

SP, in. wc (Pa)	0.25 (62)		0.5 (124)		0.75 (186)		1 (248)		1.2 (298)		1.5 (373)		1.75 (435)	
CFM (m <sup>3</sup> /hr)	RPM	W	RPM	W	RPM	W	RPM	W	RPM	W	RPM	W	RPM	W
100 (0.05)	570	10	800	20	980	40	1120	55	1230	70	1370	100	1480	120
200 (0.09)	590	15	810	35	990	50	1140	75	1250	90	1390	120	1500	145
300 (0.14)	620	30	830	50	1010	70	1150	95	1260	120	1400	150	1510	180
400 (0.19)	690	50	870	70	1030	100	1170	130	1280	155	1420	190	1530	225
500 (0.24)	770	80	920	105	1070	135	1200	170	1300	200	1440	240	1540	280
600 (0.28)	870	120	1000	150	1120	185	1240	225	1340	255	1470	305	1570	345
700 (0.33)	980	180	1090	215	1200	255	1300	295	1390	330	1510	380	1600	430
800 (0.38)	1090	255	1180	295	1280	335	1370	380	1450	420	1560	475	1650	525
900 (0.42)	1200	355	1290	395	1370	440	1460	490	1520	530	1630	590	1710	645
1000 (0.47)	1320	475	1390	520	1470	570	1550	620	1610	665	1700	730	1780	790

V3642B-1EC2

50/60 Hz

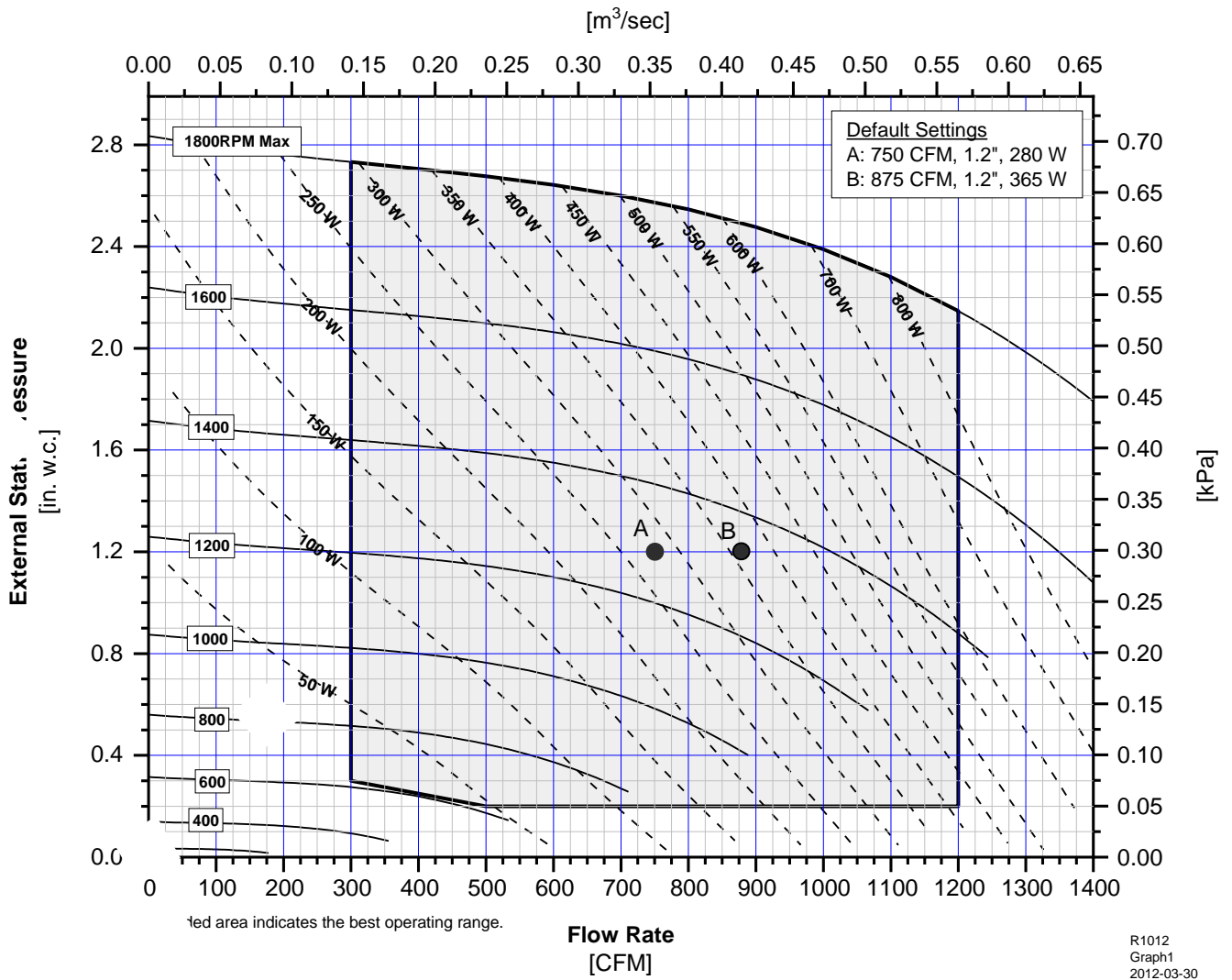

R1012  
 Graph1  
 2012-03-30

SP, in. wc (Pa)	0.25 (62)	0.5 (124)	0.75 (186)	1 (248)	1.2 (298)	1.5 (373)	1.75 (435)							
CFM (m <sup>3</sup> /hr)	RPM	W	RPM	W	RPM	W	RPM	W						
100 (0.05)	550	10	770	20	940	35	1080	50	1180	65	1320	90	1430	115
200 (0.09)	560	15	780	30	950	45	1090	65	1190	85	1330	110	1440	135
300 (0.14)	580	25	790	40	960	65	1100	85	1200	105	1340	135	1450	165
400 (0.19)	610	35	810	60	970	85	1110	110	1210	135	1350	170	1450	200
500 (0.24)	660	55	840	80	990	110	1130	145	1230	170	1360	210	1470	245
600 (0.28)	720	75	880	110	1020	145	1150	180	1250	210	1380	255	1480	295
700 (0.33)	790	110	930	145	1060	185	1180	230	1270	260	1400	310	1500	355
800 (0.38)	860	150	990	195	1110	235	1220	285	1310	320	1430	375	1520	425
900 (0.42)	940	200	1050	250	1160	300	1270	350	1350	390	1460	450	1550	505
1000 (0.47)	1020	265	1120	315	1220	370	1320	425	1390	470	1500	540	1590	595
1100 (0.52)	1100	340	1200	400	1290	455	1380	515	1450	565	1550	640	1630	700
1200 (0.57)	1190	435	1270	495	1360	555	1440	620	1510	670	1600	750	1680	820
1101 (0.52)	1270	540	1350	605	1430	670	1510	740	1570	795	1660	880	1730	950
1400 (0.66)	1360	660	1430	730	1510	805	1580	875	1630	935	1720	1025	1790	1100



## ACOUSTICAL DATA

Sound is always present and is important to comfort. Understanding how sound is defined is essential to understanding how to design a proper Unico System. Sound is defined as a physical disturbance in pressure that is detectable by the human ear. Sound is usually presented as Sound Pressure Level (SPL) in decibels (dB) but can also be presented as Sound Power Level (SWL). Sound pressure is what you hear so it is the only value that is important to the occupant. However, determining the value is difficult because it is dependent on the surroundings and distance from the sound source. For instance, a carpeted room is much quieter than a room with wood floors.

For the Unico System, it is also important to consider sound transmission losses through ceilings and walls. The blower is never placed in the occupied room, so the sound is always less than the published value. This reduction in sound level depends on the construction of the ceiling or wall. For instance, a ceiling structure made of gypsum board with insulation above it will have a much greater sound transmission loss (TL) than a dropped ceiling without insulation.

The data shown in this catalog was measured in a large room with hard surfaces for the walls and floor. It is considered to be the worst case (i.e. loudest). The sound level in the occupied space will always be considerably less than this, depending on where the unit is located. To determine the actual sound level, subtract the TL for the barrier from the sound data of the unit. The table below shows typical TL values for common construction configurations. Subtract these values from the Unico air handler data.

Transmission Loss for Common Construction, dB

Construction Type	Frequency, Hz						
	125	250	500	1k	2k	4k	R
Sheet Metal, 24 GA	13	17	20	27	34	39	<b>18</b>
Ceiling Tile, mineral fiber	13	21	27	31	35	40	<b>20</b>
Gypsum Frame wall	12	23	31	38	42	37	<b>20</b>
Gypsum Frame wall, insul.	15	30	32	43	46	38	<b>23</b>
Wood Floor, uninsulated	22	28	37	43	46	43	<b>25</b>
Wood Floor, insulated	29	40	51	57	60	58	<b>26</b>
Concrete Block, 190-mm	38	41	43	50	55	61	<b>26</b>
Concrete, 100-mm (4 in.)	41	41	45	52	56	64	<b>26</b>

Ref: *Handbook of Acoustical Measurements and Noise Control*, 1998

R = Overall Loss for typical Blower Module (based on MB4260H-50HZ)

